

Camshelving®

BASICS SERIES



smart design
uncompromised reliability
exceptional value
simply remarkable

CAMBRO
TRUSTED FOR GENERATIONS™

Camshelving® Basics

Innovative design, reliability and unmatched value come together seamlessly for the latest in commercial foodservice shelving by Cambro. Camshelving® Basics is a new dimension in shelving that offers foodservice operators savings without sacrifice.

Utilizing advanced materials and innovative design, Camshelving Basics provides: increased reliability, convenience, flexibility, improved labor efficiencies and enhanced food safety.

Camshelving Basics creates and defines an entirely new category of Cambro shelving that will equip operators with safe, strong, storage solutions in a much more affordable way than ever before.



-36° to 190°
(-38° to 88° C)



LIFETIME WARRANTY
AGAINST
RUST and CORROSION.



weight capacity

	traverse length	weight bearing capacity	
		per shelf	per unit
Single Unit (4 shelves)	30"- 48" 760 - 1220 mm	600 lbs. 272 kg	2400 lbs. 1089 kg
Single Unit (4 shelves)	54"- 60" 1380 - 1530 mm	500 lbs. 227 kg	2000 lbs. 907 kg
Dunnage Stand	54"- 60" 1380 - 1530 mm	800 lbs. 363 kg bottom shelf only	—
Corner Unit (4 shelves)	30"- 48" 760 - 1220 mm	300 lbs. 136 kg	1200 lbs. 544 kg

Dunnage Stands are recommended for units 54" (1380 mm) or longer.

Corner Connectors are recommended for use on traverses 48" (1220 mm) or less.

Camshelving® Basics

smart design

No matter the space in a foodservice operation, whether a walk-in cooler, dry-storage, sanitation or service supplies room, Camshelving Basics is designed with flexibility to fit into any space. Post Kits, Shelf Kits and optional accessories are packaged and sold individually allowing operators to build a shelving configuration to fit their storage needs, even in the most limited spaces. Similar to other shelving products by Cambro, shelf plates can be easily removed, washed individually or in sections and placed in an open-end Camrack® and washed in a commercial dishwasher.



Dry Storage



Camshelving® Basics Components are Patent Pending

uncompromised reliability

The light-weight, yet extremely durable, non-corrosive, composite material in Camshelving Basics endures even the toughest environments, including hot, cold, dry, wet and humid storage areas and supports all food safety, HACCP and sanitation recommendations. Resistant to scratching, peeling, warping, rust and corrosion, every component in Camshelving Basics was rigorously tested for strength, reliability and performance and that's exactly what customers have come to expect from Cambro.



Banquet Supplies Storage

Other storage areas might include: Janitorial / sanitation, house keeping and warewashing supplies.

ideal for

Material easily wipes clean and shelf plates are dishwasher safe thus improving labor efficiency. Further reinforcing Cambro's commitment to producing the industry's highest quality and most durable shelving solutions, Basics features a lifetime warranty against corrosion eliminating the need for unnecessary replacement costs and time-consuming procurement and installation effort.



Linen Storage

Maximize Space Utilization

Camshelving® Basics Components are Patent Pending

Post Kits

- Ship complete in one box with 2 stationary post with leveling feet installed. Assembly required with post connectors and collar wedges.

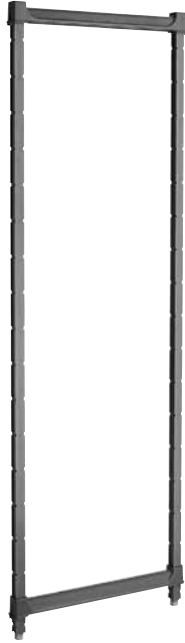

Corner Connectors

- Used to build corner and U-Shaped units.
- Easily snap onto traverses.
- Set attaches a starter unit to an add-on unit at a 90° angle or to form a U-shape. Eliminates 1 post kit.
- A set of corner connectors are needed for each shelf.
- Corner connectors are recommended for use on traverses equal to or less than 48" (1220 mm) and up to 300 lbs (136 kg.) per shelf.



Seismic Foot

- Bolts a post to the floor for a more stable base.



Wall Fastener

- Fastens a unit to a wall as a safety precaution.
- Screws not included.



Shelf Kits

- Ship complete in one box with two stationary Traverses, eight Dovetails (4 each A and B), Vented Shelf Plates to complete one shelf.



Dunnage Stand

- Increases weight bearing capacity to 800 lbs. (363 kg) on the bottom shelf only.
- Recommended for units 54" (1380 mm) or longer.



Identification Tag

- Easily clips onto traverses to identify stored items.
- Made of PVC.
- Includes 12 HACCP labels.
- Available in 6" (152 mm) only.



Configurations

Starter Unit



Starter Unit (A) with Add-on Unit (B)



Corner Unit (B)



Starter Unit with Add-on Unit and 4 Corner Connector Sets.

Camshelving® Basics Configuration Details

Starter Unit

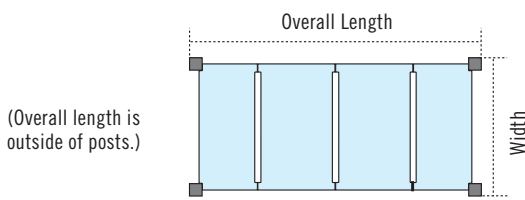

Add-on Unit

Shared posts between starter unit and add-on unit maximizes space.

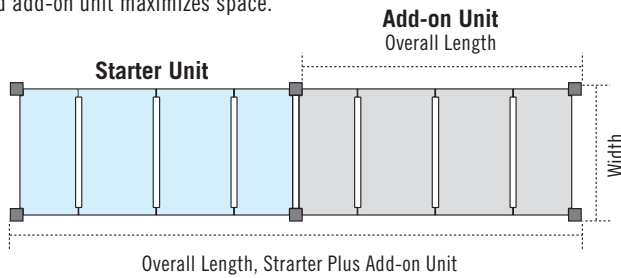

Corner Unit

Requires a Starter Unit, Add-on Unit plus one set of Corner Connectors per shelf.

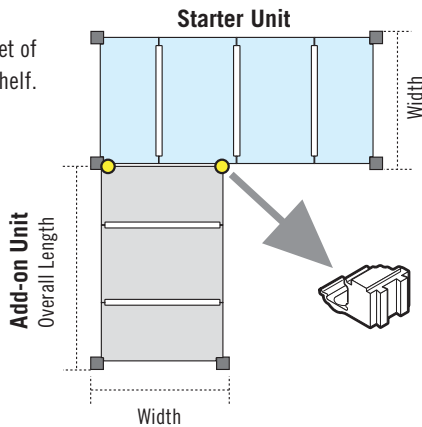

U-Shaped Unit

Requires two sets of corner connectors per shelf.

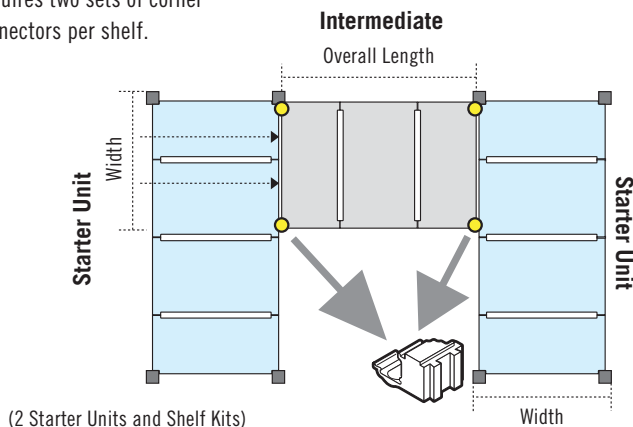

Shelf Spacing

- Notches for dovetails are spaced every 4" (100 mm).

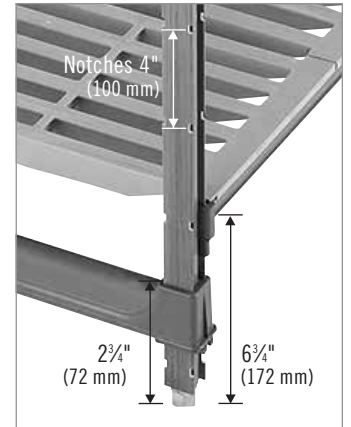

POST HEIGHT	NUMBER OF POSITIONS PER POST
Stationary	
64" (1630 mm)	14
72" (1830 mm)	16
84" (2140 mm)	19

UNIT	CORNER UNIT OVERALL LENGTH	SHELF INTERMEDIATE UNIT OVERALL LENGTH
30" (760 mm)	29" (740 mm)	28" (715 mm)
36" (910 mm)	35" (890 mm)	34" (865 mm)
42" (1070 mm)	41" (1045 mm)	40" (1020 mm)
48" (1220 mm)	47" (1195 mm)	46" (1170 mm)

Corner Connectors are recommended for use on traverses 48" (1220 mm) or less.

UNIT	BASIC UNIT OVERALL LENGTH	ADD-ON UNIT OVERALL LENGTH	BASIC + ADD-ON UNIT OVERALL LENGTH
30" (760 mm)	30" (760 mm)	28 3/4" (720 mm)	58 1/4" (1480 mm)
36" (910 mm)	36" (910 mm)	34 3/4" (870 mm)	70 1/4" (1780 mm)
42" (1070 mm)	42" (1070 mm)	40 3/4" (1025 mm)	82 1/4" (2095 mm)
48" (1220 mm)	48" (1220 mm)	46 3/4" (1175 mm)	94 1/4" (2395 mm)
54" (1380 mm)	54" (1380 mm)	52 3/4" (1330 mm)	106 1/4" (2710 mm)
60" (1530 mm)	60" (1530 mm)	58 3/4" (1480 mm)	118 1/4" (3010 mm)

Shelving Consulting

Cambro provides a free consulting service to maximize your storage area. No cost or obligation.



To contact the Camshelving Consulting Department, please call 1-714-230-4113, Fax 1-714-230-4199 or email: mperez@cambro.com.

Stationary Post Kits

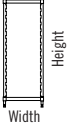
 HEIGHT 64" 1630 mm	WIDTH	18"	21"	24"
			460 mm	540 mm
	CODE	CBPK1864	CBPK2164	CBPK2464
	CASE LBS. (CUBE)	7.23 (0.46)	7.42 (0.46)	7.57 (0.46)
	CASE KG (CUBE M³)	3,28 (0,01)	3,37 (0,01)	3,43 (0,01)
	CODE	CBPK1872	CBPK2172	CBPK2472
	CASE LBS. (CUBE)	8.03 (0.52)	8.22 (0.52)	8.37 (0.52)
	CASE KG (CUBE M³)	3,64 (0,01)	3,73 (0,01)	3,80 (0,01)
	CODE	CBPK1884	CBPK2184	CBPK2484
	CASE LBS. (CUBE)	9.01 (0.61)	9.20 (0.61)	9.35 (0.61)
	CASE KG (CUBE M³)	4,09 (0,02)	4,17 (0,02)	4,24 (0,02)

Includes 2 stationary posts with leveling feet installed, 1 top post connector, 1 bottom post connector, 8 post connector wedges in a bag and instructions. Post kit ships unassembled.
Case Pack: 1 **Color:** Brushed Graphite (580).

Optional Accessories

Dunnage Stands

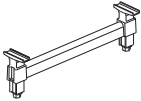
 HEIGHT 6¾" 172 mm	WIDTH	18"	21"	24"
			460 mm	540 mm
	CODE	CBDS18	CBDS21	CBDS24
	CASE LBS. (CUBE)	1.91 (0.22)	2.02 (0.26)	2.08 (0.30)
	CASE KG (CUBE M³)	0,87 (0,01)	0,92 (0,01)	0,95 (0,01)

Case Pack: 1 **Color:** Brushed Graphite (580).



DESCRIPTION	Seismic Foot	Wall Fastener	90° Left & Right Corner Connectors	ID Tag 6" (152 mm)
CODE	CSEQ3	CSWF	CBCC	CBID6
COLOR	Silver	Silver	Brushed Graphite (580)	White / Clear
CASE LBS. (CUBE)	1.43 (0.04)	4.08 (0.27)	0.36 (0.05)	0.82 (0.28)
CASE KG (CUBE M³)	0,62 (0,011)	1,85 (0,006)	0,16 (0,00)	0,37 (0,01)
CASE PACK	4 each	4 each	1 set	12 each

Vented Shelf Kits for Stationary Units

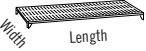
 WIDTH 18" 460 mm	LENGTH	30" 760 mm	36" 910 mm	42" 1070 mm	48" 1220 mm
	CODE	CBSK1830V	CBSK1836V	CBSK1842V	CBSK1848V
CASE LBS. (CUBE)	5.68 (0.96)	7.01 (1.51)	8.39 (2.03)	8.83 (1.54)	
CASE KG (CUBE M³)	2,58 (0,03)	3,18 (0,04)	3,81 (0,06)	4,01 (0,04)	
21" 540 mm	CODE	CBSK2130V	CBSK2136V	CBSK2142V	CBSK2148V
CASE LBS. (CUBE)	6.24 (0.96)	7.65 (1.51)	9.15 (2.03)	9.67 (1.54)	
CASE KG (CUBE M³)	2,83 (0,03)	3,47 (0,04)	4,15 (0,06)	4,39 (0,04)	
24" 610 mm	CODE	CBSK2430V	CBSK2436V	CBSK2442V	CBSK2448V
CASE LBS. (CUBE)	6.64 (0.96)	8.20 (1.51)	9.78 (2.03)	10.45 (1.54)	
CASE KG (CUBE M³)	3,01 (0,03)	3,72 (0,04)	4,44 (0,06)	4,74 (0,04)	

SINGLE SHELF - Includes vented shelf plates for 1 shelf, 2 stationary traverses, 1 bag of 8 stationary traverse dovetails (4 each A and B) and instructions.

Case Pack: 1 Color: Brushed Graphite (580).

Vented Shelf Kits for Stationary Units

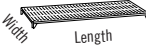
 WIDTH 18" 460 mm	LENGTH	54" 1380 mm	60" 1530 mm
	CODE	CBSK1854V	CBSK1860V
CASE LBS. (CUBE)	10.51 (2.57)	11.86 (2.85)	
CASE KG (CUBE M³)	4,76 (0,07)	5,38 (0,08)	
21" 540 mm	CODE	CBSK2154V	CBSK2160V
CASE LBS. (CUBE)	11.47 (2.57)	12.90 (2.85)	
CASE KG (CUBE M³)	5,20 (0,07)	5,85 (0,08)	
24" 610 mm	CODE	CBSK2454V	CBSK2460V
CASE LBS. (CUBE)	12.33 (2.57)	13.91 (2.85)	
CASE KG (CUBE M³)	5,59 (0,07)	6,31 (0,08)	

SINGLE SHELF - Includes vented shelf plates for 1 shelf, 2 stationary traverses, 1 bag of 8 stationary traverse dovetails (4 each A and B) and instructions.

Case Pack: 1 Color: Brushed Graphite (580).

Vented 4-Shelf Stationary Starter Units

18" Width (460 mm)

 HEIGHT 72" 1830 mm	LENGTH	36"	42"	48"	54"	60"
		910 mm	1070 mm	1220 mm	1380 mm	1530 mm
CODE CASE LBS. (CUBE) CASE KG (CUBE M ³)	CODE	CBU183672	CBU184272	CBU184872	CBU185472	CBU186072
	CASE LBS. (CUBE)	40.89 (5.92)	44.13 (5.92)	47.65 (5.92)	51.13 (5.92)	54.41 (5.92)
	CASE KG (CUBE M ³)	18,55 (0,17)	20,01 (0,17)	21,61 (0,17)	23,19 (0,17)	24,68 (0,16)

Includes 4 stationary posts with leveling feet installed - pre-assembled with post connectors and wedges, 4 bags of 8 stationary traverse dovetails (4 A and 4 B), vented shelf plates (for 4 shelves), 8 stationary traverses and instructions.
Case Pack: 1 Color: Brushed Graphite (580).

21" Width (540 mm)

 HEIGHT 72" 1830 mm	LENGTH	36"	42"	48"	54"	60"
		910 mm	1070 mm	1220 mm	1380 mm	1530 mm
CODE CASE LBS. (CUBE) CASE KG (CUBE M ³)	CODE	CBU213672	CBU214272	CBU214872	CBU215472	CBU216072
	CASE LBS. (CUBE)	44.49 (7.39)	48.21 (7.39)	52.05 (7.39)	56.01 (7.39)	59.61 (7.39)
	CASE KG (CUBE M ³)	20,18 (0,21)	21,87 (0,21)	23,61 (0,21)	25,40 (0,21)	27,04 (0,21)

Includes 4 stationary posts with leveling feet installed - pre-assembled with post connectors and wedges, 4 bags of 8 stationary traverse dovetails (4 A and 4 B), vented shelf plates (for 4 shelves), 8 stationary traverses and instructions.
Case Pack: 1 Color: Brushed Graphite (580).

24" Width (610 mm)

 HEIGHT 72" 1830 mm	LENGTH	36"	42"	48"	54"	60"
		910 mm	1070 mm	1220 mm	1380 mm	1530 mm
CODE CASE LBS. (CUBE) CASE KG (CUBE M ³)	CODE	CBU243672	CBU244272	CBU244872	CBU245472	CBU246072
	CASE LBS. (CUBE)	47.92 (8.48)	51.96 (8.48)	56.40 (8.48)	60.68 (8.48)	64.88 (8.48)
	CASE KG (CUBE M ³)	21,73 (0,24)	23,57 (0,24)	25,58 (0,24)	27,52 (0,24)	29,43 (0,24)

Includes 4 stationary posts with leveling feet installed - pre-assembled with post connectors and wedges, 4 bags of 8 stationary traverse dovetails (4 A and 4 B), vented shelf plates (for 4 shelves), 8 stationary traverses and instructions.
Case Pack: 1 Color: Brushed Graphite (580).

Vented 4-Shelf Stationary Add-On Unit 24" Width (610 mm)

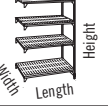
 HEIGHT 72" 1830 mm	LENGTH	48"
		1220 mm
CODE CASE LBS. (CUBE) CASE KG (CUBE M ³)	CODE	CBU244872
	CASE LBS. (CUBE)	49.25 (8.48)
	CASE KG (CUBE M ³)	22,34 (0,24)

Includes 2 stationary posts with leveling feet installed - pre-assembled with post connectors and wedges, 4 bags of 8 stationary traverse dovetails (4 A and 4 B), vented shelf plates (for 4 shelves), 8 stationary traverses and instructions.
Case Pack: 1 Color: Brushed Graphite (580).



Camshelving® Basics Components are Patent Pending.
 Corner Connector Left (CBCCL), Corner Connector Right (CBCCR), Seismic Foot (CSEQ3), Wall Fastener (CSWF) and Identification Tag (CBID6) are not NSF Listed.

www.cambro.com



Telephone 714 848 1555 Toll Free 800 854 7631 Customer Service 800 833 3003
 © Cambro Manufacturing Company 5801 Skylab Road, Huntington Beach, California 92647-2056
 LIT1317 Printed in USA 06/13.



D061318